

Type-Tested Power Distribution Board 8PT
Versatile with safety

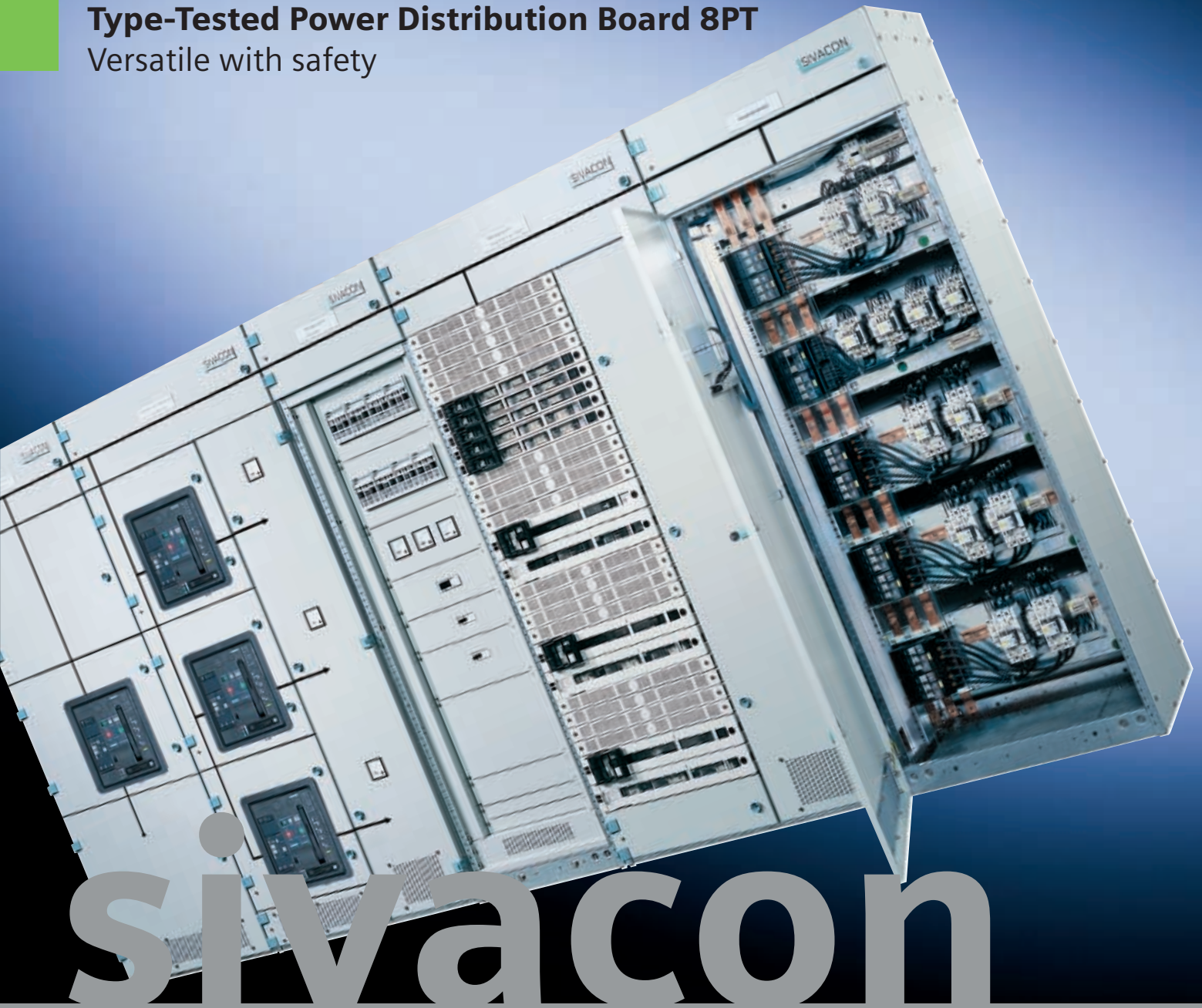

sivacon



SIEMENS



The Obvious Solution for Global Challenges – **SIVACON**

Type testing in low-voltage switchgear is increasingly becoming an issue of prime importance worldwide. In future, there will be no other solution. But how far does one really have to go to accomplish a type test? Often too far.

But that is now a thing of the past. With the "SIVACON Technology Partner" concept, Siemens is bringing the versatile and type-tested SIVACON low-voltage switchboard to your door.

To this end, Siemens has picked competent, local switchgear manufacturers and has appointed them SIVACON Technology Partners.

Your SIVACON Technology Partner will receive the concentrated know-how of Siemens at terms and conditions that only a local vendor is able to offer. For you, this means: SIVACON including type testing – faster, more flexibly and at lower cost than ever before.

Your advantage: "SIVACON Technology Partners"

These are qualified and permanently audited switchboard panel manufacturers, which Siemens has selected, close to you. This means that you always have the wealth of Siemens know-how at conditions that only a local supplier can offer. Fast, flexible and favorably priced.

SIVACON
Siemens Technology





Versatile with Safety –

Type-tested components
for power distribution
pages 4–5

Always Flexible –

SIVACON adapts to
your requirements
pages 6–7

Frame and Enclosure –

Dimensionally accurate and stable
page 8

Variable Busbar System –

The answer to diverse
requirements
page 9

Circuit-Breaker Design –

Compact, reliable and user-friendly
pages 10–11

Fixed-Mounted Design –

Economical, reliable and variable
pages 12–14

Reactive Power Compensation –

Lower costs with increased safety
page 15

In-Line Plug-in Design 3NJ6 –

Plugged-in swiftly, always safe
page 16

Cubicle for Customised Solutions –

Plenty of space for flexibility
page 17

Type-Tested Switchgear and Controlgear Assembly (TTA) –

Signed, sealed and delivered safety
page 18

Technical Data –

At a glance
page 19

Versatile with Safety – Type-Tested Components for Power Distribution

The SIVACON low-voltage switchboard is the standard solution for building and industrial technology.

SIVACON is tailored to the needs of the world market, i.e. it takes into account the call for standard solutions from a single source on the one hand and on the other for local production and the resulting advantages in terms of financing and procurement close to the plant.

As a power distribution board, SIVACON is available throughout the world and can be used at all power levels up to 7400 A, as withdrawable as well as plug-in and fixed-mounted units.

Modular Technology

Every SIVACON is made exclusively from standardized and type-coded modules. All modules are of high quality and conform to Siemens design specifications.

The multiple possibilities of combining the components fulfill every requirement.

The exclusive use of high-quality Siemens switchgear ensures a long service endurance and reliable operation.

*The versatile SIVACON
low-voltage switchboard*

- Safety and proven quality for every system by type testing
- Siemens switchgear for reliable operation
- Worldwide presence with local production
- High flexibility for economical solutions



SIVACON Features

- Type-tested standard modules (TTA)
- Standardized busbar position at the top of the cubicle
- 3- and 4-pole busbar system up to 7400 A
- Rated peak withstand current I_{pk} up to 375 kA
- Deep switchgear compartment for universal installation
- Modular structure of device compartments
- Single-front and back-to-back installation
- Cable lead-in from above or below
- Cable connection from the front or rear



Always Flexible – SIVACON Adapts to your Requirements

Modular technology makes it possible to adapt SIVACON optimally to all requirements.

- Standard horizontal busbar position at the top of the cubicle
- Any components can be installed in the device compartments regardless of the busbar position and cubicle depth
- Requirement-oriented compartmentalization of functional units (Form 1 to Form 4 according to IEC 60439-1)
- Deep device compartments

Optimum Adaptation to Space Conditions

- Wall-mounted or free-standing
- Cables and busbars may be connected optionally from above or below
- Cabling compartments front- or rear-located
- Good accessibility of busbars

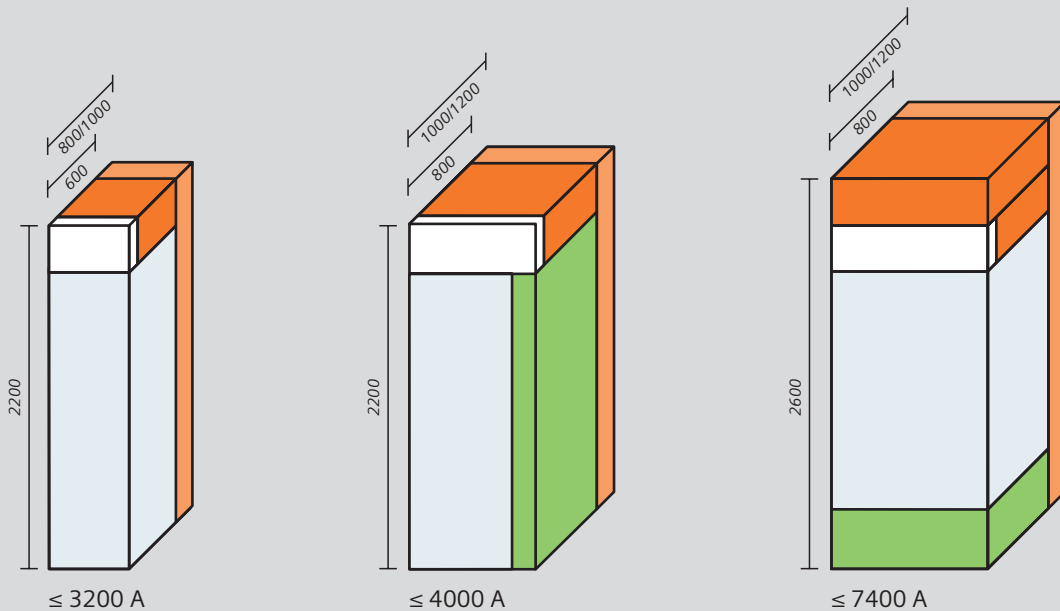

- Device compartment
- Cross-wiring compartment (optional)
- Horizontal busbar compartment

- Cable connection compartment optionally at the side or bottom (depending on the technology used)
- Cable compartment for cable connection rear or cables from above

SIVACON for
All Applications
in the
Low-Voltage Network

Power Center

I_n to 7400 A
 I_{cw} to 150 kA
 I_{pk} to 375 kA

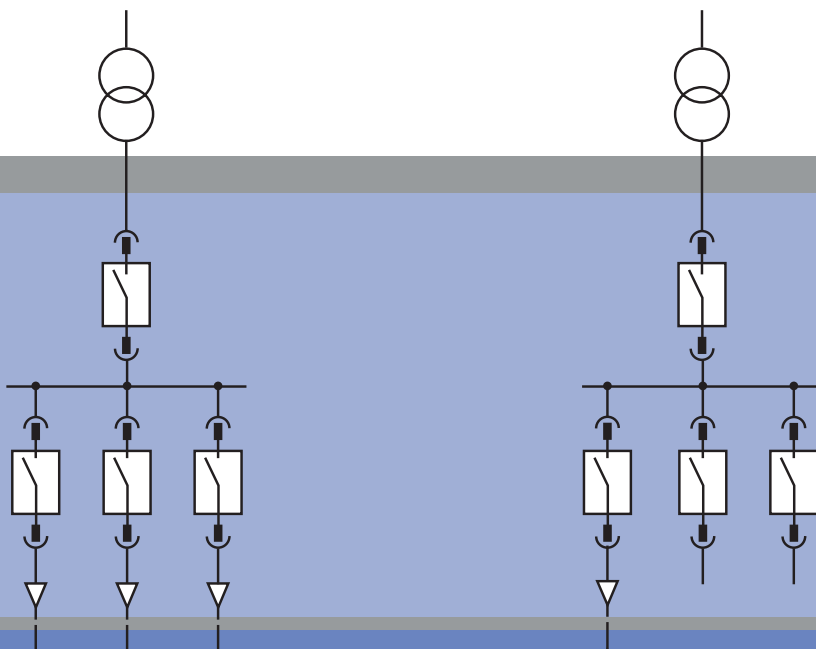

Main distribution board

I_n to 4000 A
 I_{cw} to 100 kA
 I_{pk} to 250 kA

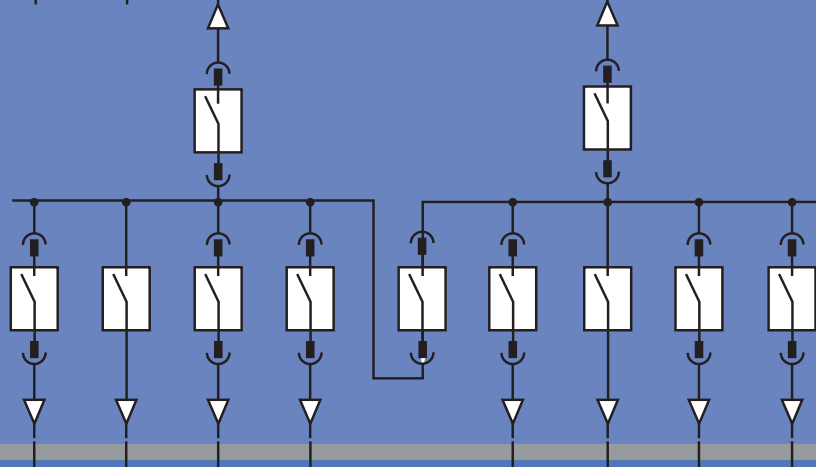

Subdistribution board

I_n to 3200 A
 I_{cw} to 80 kA
 I_{pk} to 200 kA

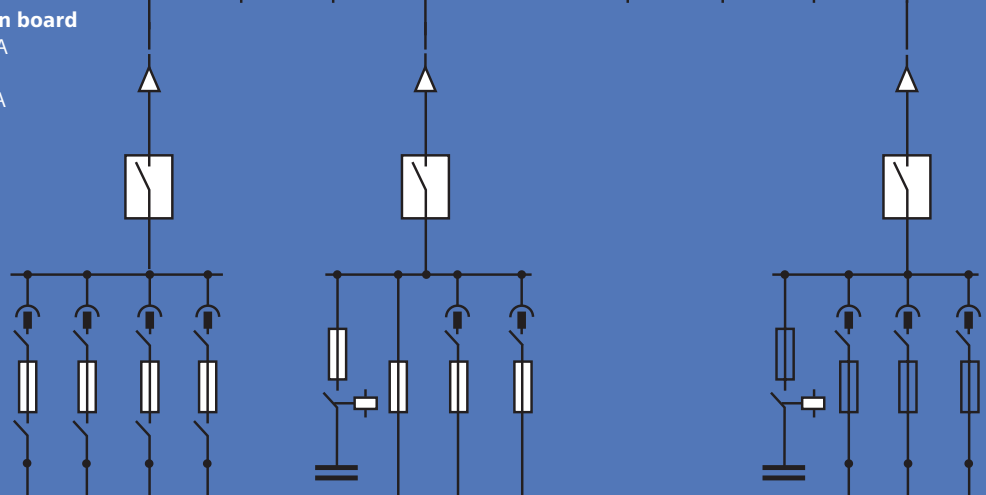

Loads



Frame and Enclosure – Dimensionally Accurate and Stable



The frame consists of rigid sheet steel sections that are linked to one another: SIVACON's dimensionally accurate and sturdy frame is available in bolted or welded versions.

- All-round perforation rows with a 25-mm hole grid for individual installation
- Flexible door system for all requirements
- Door opening angle up to 180°
- Spring-loaded locks reliably prevent doors from opening unintentionally
- Pressure-relief top covers

Surface Treatment:

Optionally powder-coated, wet-painted or sendzimir-galvanized

Material:

Frame and enclosure are manufactured from sheet steel in the following thicknesses:

Frame: 2.5 mm
Enclosure: 2.0 mm

Degrees of Protection to IEC 60529

IP 30, IP 31, IP 40, IP41, IP 42 naturally ventilated
IP 40, IP 54 unventilated

Cubicle Dimensions (Without Enclosure)

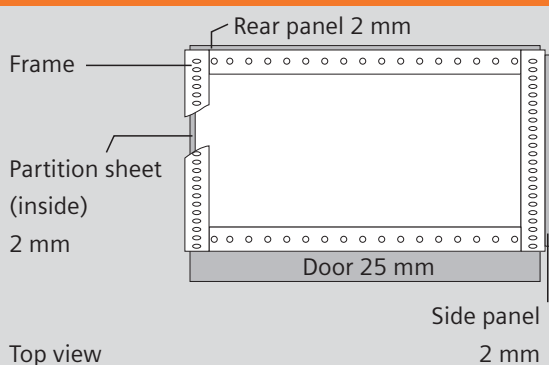

Cubicle height (mm)	Cubicle width (mm)	Cubicle depth (mm)
2200	400, 600, 800, 1000, 1200	600, 800, 1000, 1200
2600	400, 600, 800, 1000, 1200	800, 1000, 1200

Variable Busbar System – The Answer to Diverse Requirements

Differing requirements for the busbar system call for individual options.

SIVACON offers modules for economical setup and high level of safety.

- Busbar position at top
- Busbar system for rated currents up to 7400 A
- User-oriented gradation of rated currents
- Rated peak withstand current I_{pk} up to 375 kA
- Separation of the busbar compartment from the device compartment
- Transport unit joints easily accessible from above
- Arc barriers for limiting the effects of the arcing fault



Busbar System

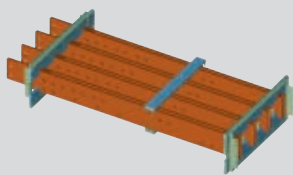

up to 3200 A

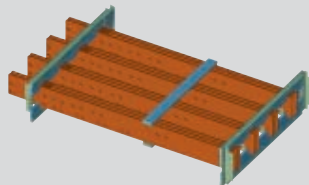

up to 4000 A

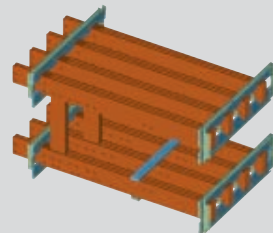

up to 7400 A



Rated Currents at 35 °C Ambient Temperature

Phase conductors (L1, L2, L3), Quantity, Dimensions (mm)	Unventilated A	Naturally ventilated A	I_{pk} / I_{cw} kA	Cubicle height mm	Cubicle depth mm
2 x 100 x 10	2400	3200	200/80	2200	600, 800, 1000
3 x 100 x 10	2950	4000	250/100	2200	800, 1000, 1200
3 x 100 x 10+ 3 x 100 x 10	5400	7400	375/150	2600	800, 1000, 1200

Circuit-Breaker Design – Compact, Reliable and User-Friendly

The supply, feeder and coupling cubicles of the circuit-breaker design are equipped with withdrawable or fixed-mounted 3W. circuit breakers (ACB).

As a large number of loads are generally connected to these cubicles, particular importance is attached to them in terms of the long-term operating reliability and personal safety of the switchboard.

SIVACON meets these requirements with circuit-breaker design components.

Compact and Reliable

- High degree of safety due to type-tested standard modules (TTA)
- Test and disconnected positions with door closed
- Circuit breakers integrated in separate compartments, each equipped with a separate door
- Optimum connection conditions for every rated current range
- Cable connection from above or below

User-Friendly with 3W.

Siemens 3W. fixed-mounted and withdrawable circuit breakers are used for the rated current range from 630 to 6300 A. This means:

- Free choice of the supply direction without any restrictions in terms of technical data
- High short-time current-carrying capacity for time-graded short-circuit protection up to 400 ms assures reliable operation of sections of the switchboard not affected by a short-circuit
- Short-circuit protection with short-time grading control (ZSS) for very brief delay times (50 ms), irrespective of the grading level
- LCD operating current indication in the control console (without ammeters and current transformers)
- Indication and operation when the door is closed

Cubicle Dimensions/Cubicle Structure

Circuit Breaker 3W.:

630 A–3200 A
cable connection

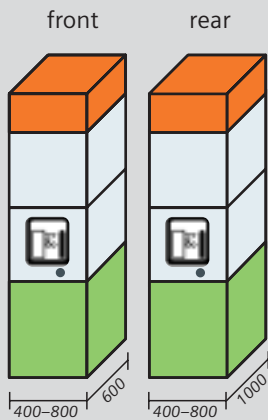

Horizontal busbar system
≤ 3200 A

630 A–6300 A
cable connection

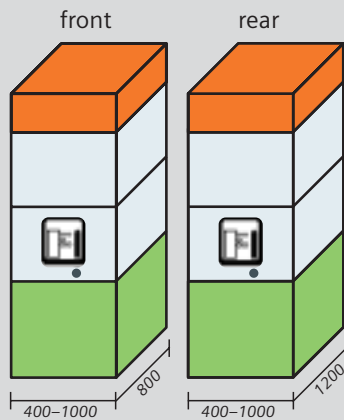

Horizontal busbar system
≤ 4000 A and ≤ 7400 A

2000 A–2500 A
cable connection



630 A–1600 A
cable connection

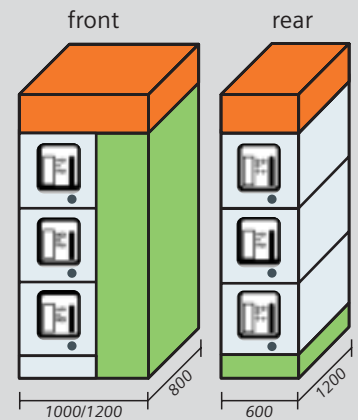



Switching Device Compartment

- Reliable travel of the circuit breaker while the door is closed
- A maintenance position allows direct local inspection without removal of the circuit breaker



Reliable travel of the circuit breaker while the door is closed

Cable or Busbar Connection Compartment

- Cable or busbar connection optionally from above or below
- A rated current-dependent connection compartment offers optimum termination conditions for cables and busbars
- Assembly times are shortened by optimum connection compartments



Optimum connection compartments for high safety

Fixed-Mounted Design – Economical, Reliable and Variable

The cubicles for cable feeders in fixed-mounted execution are equipped with molded-case circuit breakers or fuse-switch disconnectors (conventional or in-line), depending on requirements.

These cubicles are used for applications in which replacement under operating conditions is not necessary or where short downtimes are acceptable.

In this case, the SIVACON fixed-mounted design offers excellent economy, safety and variability.

Modular Cable Feeders

The modular cable feeders enable efficient installation, above all whenever operation-specific changes or adaptations are necessary.

- Molded-case circuit breakers or fuse-switch disconnectors can be fitted as required
- Free combination of cable feeders within one cubicle
- Continuously adjustable mounting plates for a standard front plane
- Cable feeders with and without current measurement



Cable feeder with circuit breaker attached to mounting plate

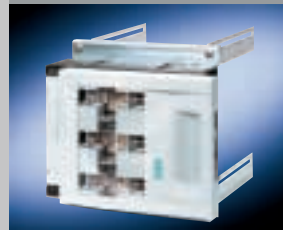

Cable feeder with fuse-switch disconnector attached to mounting plate

- High degree of safety due to type-tested standard modules (TTA)
- Any combination of modular cable feeders
- Swift conversion due to lateral universal distribution busbar
- Easy replacement of cable feeders after deenergizing the switchboard

Cubicle Dimensions/Cubicle Structure

Circuit Breaker 3RV / 3VL and fuse-switch disconnectors 3NP
Cable connection right-hand side

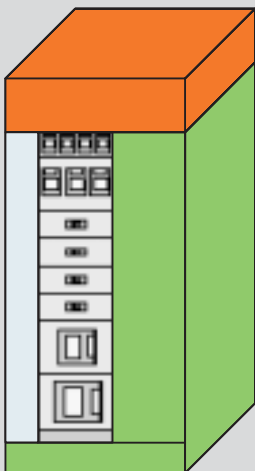

600/800/1000
up to 630 A/feeder



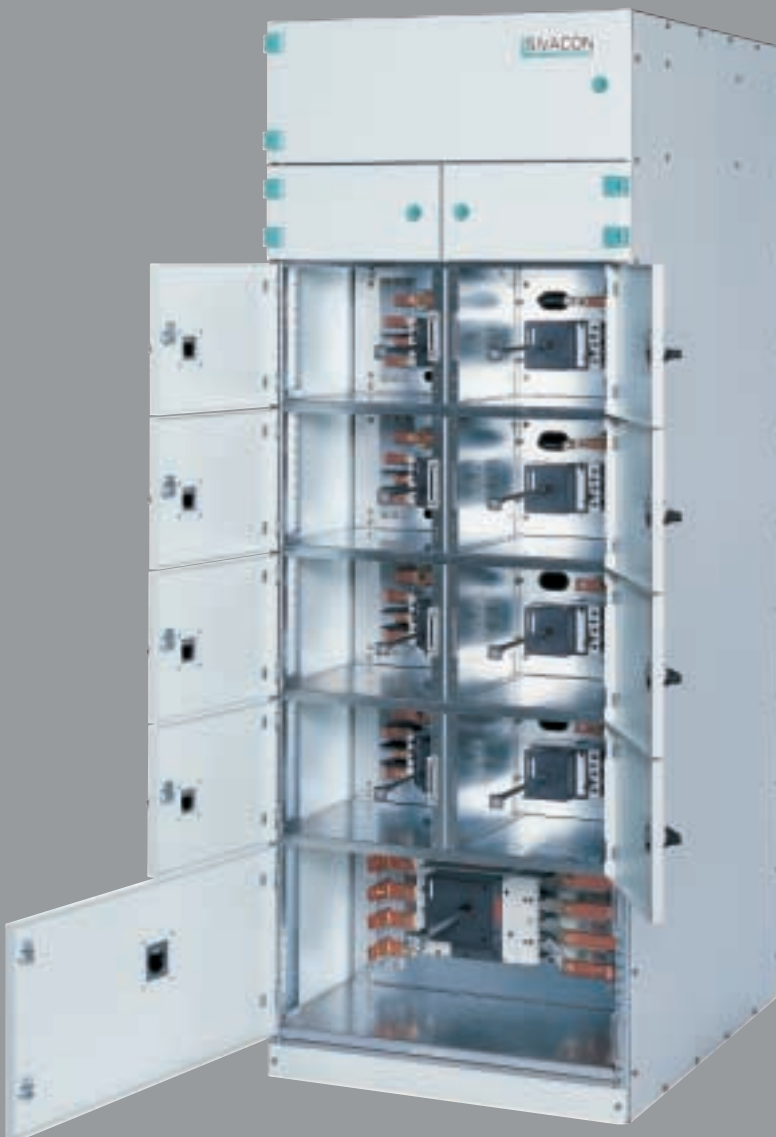

Cable feeders in compartment design

The compartment design with its individual sub-section for every circuit breaker offers increased active safety for installation and personnel protection.

- Individual sub-sections with doors for each circuit breaker
- Circuit breaker 3VL with or without plug-in socket
- High form of internal separation up to Form 4 Type 7 acc. to BS EN 60439 (gland box per functional unit)
- Optimum connection conditions in the rear cable connection compartment



Cable connection compartment at the rear with one cable gland box per functional unit, internal separation Form 4 Type 7 acc. to BS EN 60439

Cubicle Dimensions/Cubicle Structure

Circuit breaker 3RV / 3VL
Cable connection rear



up to 630 A/feeder

Fixed-Mounted Design – Economical, Reliable and Variable

Switchable In-Line Fuse-Switch Disconnectors

The in-line fuse-switch disconnectors make for optimum packing density thanks to their compact design and their modular structure.

- Cable feeders up to 630 A with/without current metering
- 25 feeders can be installed in each cubicle
- Dead-state fuse replacement



*In-line fuse-switch
disconnector
3NJ4*



Cubicle Dimensions/Cubicle Structure

In-line fuse-switch disconnectors 3NJ4

Cable connection right-hand side

Cable connection bottom

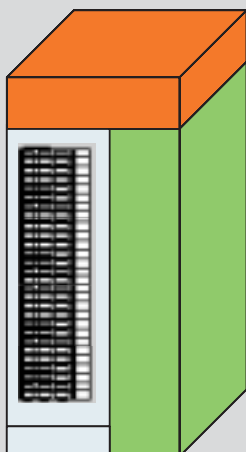

up to 160 A/feeder

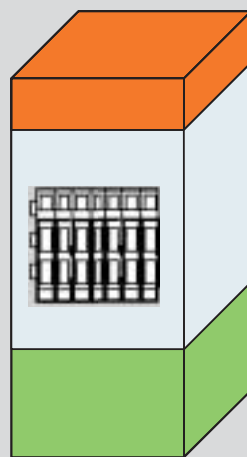

up to 630 A/feeder

Reactive Power Compensation – Lower Costs with Increased Safety

The cubicles for central reactive power compensation ease the load on transformers and cables, reduce transmission losses and save current costs. Depending on the load structure, they are equipped with chokeless or choked capacitor modules.

Controller Module with Electronic Power Factor Controller for Flush Door Mounting

- Multifunction display
- Self-adaption of the C/k value
- Adjustable nominal cos phi from 0.8 ind to 0.98 cap
- Manual/automatic operation

Capacitor Module up to 100 kvar

- Fuse-switch disconnectors
- Capacitor contactors
- MKK power capacitors
- Discharging units
- Filter circuit chokes

Cubicle Dimensions/Cubicle Structure

Reactive power compensation

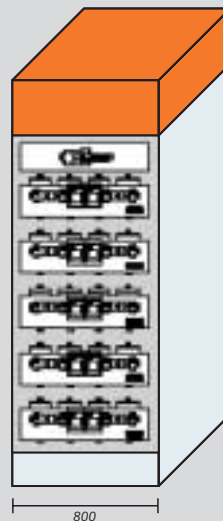

Chokeless up to 500 kvar

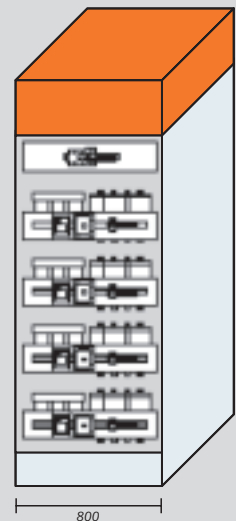

Choked type up to 300 kvar

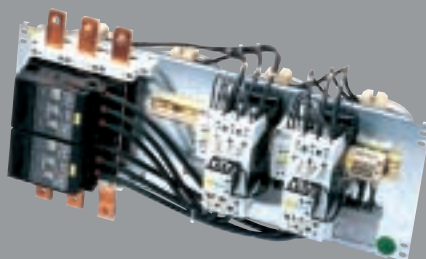

Capacitor module,
100 kvar (chokeless)

In-Line Plug-in Design 3NJ6 – Plugged-in Swiftly, Always Safe

The in-line plug-in design outgoing feeders represent a low-priced alternative to the withdrawable-unit design. By virtue of the supply-side plug-in contact and their compact design, the modules provide the facility for easy and quick interchangeability without switchboard shutdown. With the in-line plug-in design, SIVACON offers good cost-effectiveness, safety and flexibility.

- High level of safety by virtue of type-tested standard modules (TTA)
- Supply-side plug-in contacts enable quick replacement
- In-line type switching devices for cable feeders up to 630 A available in the following designs:
 - Fuse module with fuses
 - Fuse-switch disconnectors (single-break)
 - Fuse-switch disconnectors (double-break)
 - Switch disconnectors
- High packing density (up to 34 feeders per cubicle)
- Dead-state fuse replacement
- Protection against electric shock from plug-on bus system
- 400 and 600 mm wide cable connection compartment
- Degree of protection up to IP 40
- Possibility of replacing a feeder without having to shut down the system



Cubicle Dimensions/Cubicle Structure

Plug-in switch disconnectors 3NJ6
Cable connection right-hand side

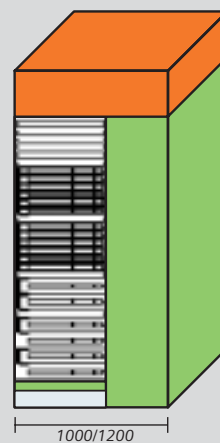

up to 630 A/feeder



Plug-in switch disconnector 3NJ6
with 250-A fuses featuring supply-
side plug-in contacts

Cubicle for Customised Solutions – Plenty of Space for Flexibility

Various installation components are available for customised solutions, e.g. for open and closed-loop control tasks.

- 3- and 4-pole vertical distribution busbars
- Rated currents up to 1200 A
- Rated short-time withstand current up to I_{cw} 65 kA
- Cubicle-length doors or compartment doors
- Compartmentalization
- Various installation components



Cubicle Dimensions/Cubicle Structure

Cubicle for customised solutions up to 1200 A

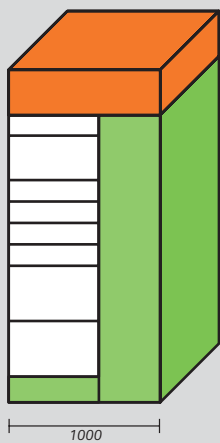
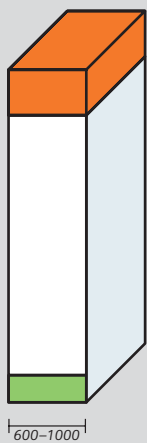

Type-Tested Switchgear and Controlgear Assembly (TTA) – Signed, Sealed and Delivered Safety

SIVACON is a type-tested switchgear and controlgear assembly (TTA) whose physical characteristics were designed in the test laboratory both for normal operating conditions and for fault situations. Conclusive type tests assure a maximum of reliability and personal safety. SIVACON has passed the following verification tests as detailed in IEC 60439-1, DIN EN 60439-1 (VDE 0660 Part 500):

Type Testing

- Verification of temperature rise limits by test
- Verification of dielectric properties by test
- Verification of the short-circuit withstand strength by test
- Verification of the effective connection between the exposed conductive parts of the assembly and the protective circuit by inspection or resistance measurement
- Verification of the short-circuit withstand strength of the protective circuit by test
- Verification of clearances and creepage distances
- Verification of mechanical operation
- Verification of the degree of protection

Every SIVACON Switchboard Undergoes Routine Testing Before Delivery:

- Inspection of the assembly including wiring and, if necessary, electrical operation test
- Dielectric test
- Checking of protective measures and of the electrical continuity of the protective circuits

These Safety Requirements are Supported by a Series of Details in SIVACON, for Example:

- With the withdrawable circuit-breaker design, operating errors are ruled out by exactly shaped mechanical guides and interlocks
- Only a few, exclusively high-quality insulating materials are used (e.g. for busbar supports, reinforcements, etc.)
- Use of high-quality Siemens switchgear ensures long lifetime and minimized downtimes
- Reliable disconnection after 70 to 100 ms, even at long-time delays by 3WN circuit breakers with short-time grading control (ZSS)
- Computer-assisted configuring ensures error-free selection and arrangement of items
- Arcing fault-tested
- Effective quality management

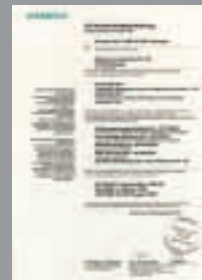

Technical Data – At a Glance

Standards and specifications	Type-tested low-voltage switchgear and control gear assembly (TTA) Testing of response to internal faults (arcing faults)	IEC 60439-1, DIN EN 60439-1 (VDE 0660 Part 500) IEC 61641, VDE 0660 Part 500, Supplement 2	
Creepage distances and clearances	Rated impulse withstand voltage (U_{imp})	8 kV	
	Overvoltage category	III	
	Pollution degree	3	
Rated insulation voltage (U_i)		1000 V	
Rated operational voltage (U_e)		up to 690 V	
Rated currents (I_n) Busbars (3-pole and 4-pole)	Main horizontal busbars	Rated current	up to 7400 A
		Rated peak withstand current (I_{pk})	up to 375 kA
		Rated short-time withstand current (I_{cw})	up to 150 kA, 1 s up to 120 kA, 3 s
	Vertical busbars for circuit breakers	Rated current	up to 6300 A
	Rated peak withstand current (I_{pk})	up to 250 kA	
	Rated short-time withstand current (I_{cw})	up to 100 kA, 1 s up to 80 kA, 3 s	
	Vertical busbars for fixed-mounted design	Rated current	up to 1400 A
		Rated peak withstand current (I_{pk})	up to 163 kA
		Rated short-time withstand current (I_{cw})	up to 65 kA*, 1 s up to 50 kA, 3 s
	Vertical busbars for in-line plug-in design (3NJ6)	Rated current	up to 2100 A
		Rated peak withstand current (I_{pk})	up to 110 kA
		Rated short-time withstand current (I_{cw})	up to 50 kA*, 1 s
Switchgear rated currents		Circuit breakers	up to 6300 A
		Outgoing feeders	up to 630 A
Internal separation	Form 1 to Form 4	IEC 60439-1, Section 7.7, DIN EN 60439-1	
Surface treatment	Frame parts	Galvanized/powder-coated/wet-painted	
	Enclosure	Galvanized/powder-coated/wet-painted	
	Doors	Powder-coated/wet-painted	
Degree of protection	To IEC 60529, EN 60529	IP 30 to IP 54	
Dimensions		Height: 2200, 2600 mm (with busbar top unit) Width: 400, 600, 800, 1000, 1200 mm Depth: 600, 800, 1000, 1200 mm	

* Rated conditional short-circuit current I_{CC} up to 100 kA

Siemens AG

Automation and Drives

Low Voltage Controls and Distribution Division

P.O. Box 32 40, D-91050 Erlangen

www.siemens.com/sivaco